

DAC81408EVM

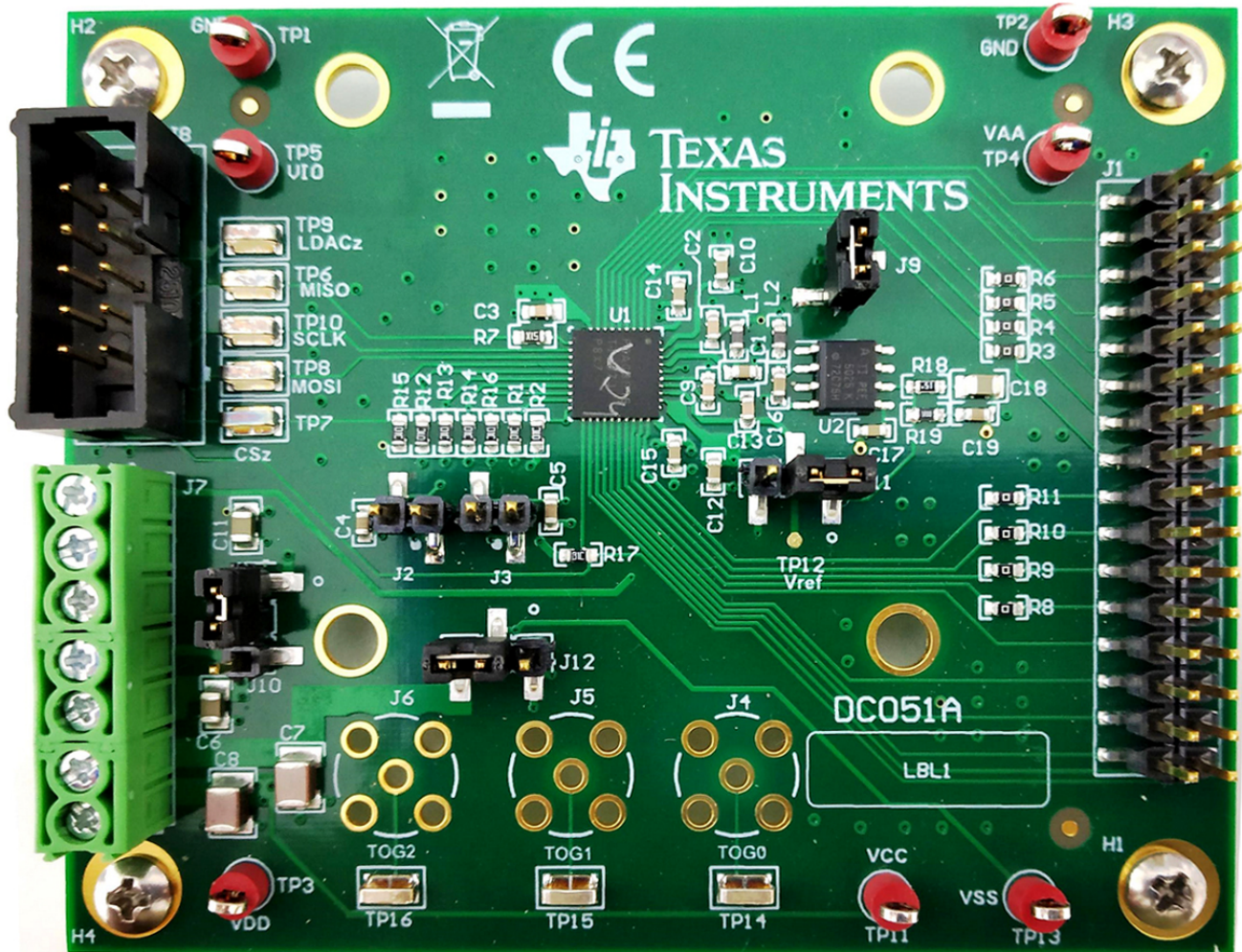

This user's guide describes the characteristics, operation, and use of the DAC81408 evaluation module (EVM). This document also discusses the proper setup and configuration of both software and hardware, and reviews various aspects of program operation. Throughout this document, the terms evaluation board, evaluation module, and EVM are synonymous with the DAC81408EVM. A complete circuit description, schematic diagram, and bill of materials are also included in this document.

Contents

1	Overview	3
2	System Setup	4
3	Detailed Description	6
4	Schematic, PCB Layout, and Bill of Materials	13

List of Figures

1	DAC81408EVM Hardware Setup	4
2	Launching Software Setup	5
3	DAC81408EVM Installation Path	5
4	DAC81408EVM Hardware Block Diagram	6
5	DAC Output Header	8
6	DAC81408EVM GUI Location	9
7	DAC81408EVM GUI Connection Detection	9
8	DAC81408EVM Software Page Selection	10
9	Low Level Configuration Page	11
10	Low Level Configuration Page Options	11
11	High Level Configuration Page	12
12	DAC81408EVM Board Schematic	13
13	DAC81408EVM PCB Components Layout	14
14	Top Layer	15
15	Layer 2 - Ground Plane	16
16	Layer 3 - Power Plane	17
17	Bottom Layer	18

List of Tables

1	Contents of DAC81408EVM Kit	3
2	Required Components Not Included in DAC81408EVM Kit	3
3	Related Documentation	3
4	Power Supply Inputs	4
5	Jumper Settings	6
6	J8 (USB2ANY) Pin Definitions	7
7	J8 SPI Signal Test Points	7
8	J1 Pin Definitions	8
9	DAC81408 EVM Bill of Materials	19

Trademarks

Windows is a trademark of Microsoft Corporation.
All other trademarks are the property of their respective owners.

1 Overview

The DAC81408EVM is an easy to use platform for evaluating the functionality and performance of the DAC81408 device. The DAC81408 is a 8-channel, buffered, high-voltage output digital-to-analog converter (DAC) in 16-bit resolution with 2.5-V internal reference. This EVM provides bipolar output voltage up to ± 20 V and unipolar up to 40 V. The EVM provides the SPI programming interface using a PC-based graphical user interface (GUI).

1.1 Kit Contents

[Table 1](#) details the contents of the EVM kit. Contact the TI Product Information Center nearest you if any component is missing. TI highly recommends that the user verify latest versions of the related software at the TI website, www.ti.com.

Table 1. Contents of DAC81408EVM Kit

Item	Quantity
DAC81408EVM evaluation board PCB	1

Table 2. Required Components Not Included in DAC81408EVM Kit

Item	Quantity
USB2ANY interface adapter	1

1.2 Related Documentation from Texas Instruments

The following document provides information regarding Texas Instruments integrated circuits used in the assembly of the DAC81408EVM. This user's guide is available from the TI web site under literature number SLAU778. Any letter appended to the literature number corresponds to the document revision that is current at the time of the writing of this document. Newer revisions may be available from the TI web site at <http://www.ti.com/>, or call the Texas Instruments Literature Response Center at (800) 477-8924 or the Product Information Center at (972) 644-5580. When ordering, identify the document by both title and literature number.

Table 3. Related Documentation

Document	Literature Number
DAC81408 product data sheet	SLASER3

2 System Setup

2.1 Hardware Setup

This section provides the overall system setup for the EVM. Use a PC to run the software that provides an interface to the USB2ANY platform. This platform generates the optional VIO power and digital signals used to communicate with the EVM board. Test point connections are included on the EVM board for external power supplies. [Figure 1](#) displays the system setup for the DAC81408EVM.

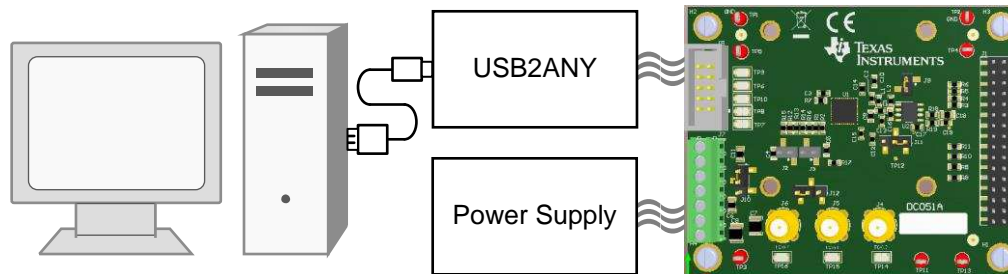

Figure 1. DAC81408EVM Hardware Setup

2.1.1 Connecting the Hardware

Connect the USB cable from the USB2ANY platform to the PC. To connect the USB2ANY to the EVM board, align and firmly connect the keyed ribbon connector to the J8 connector. Verify that the connection is snug because loose connections may cause intermittent operation.

2.1.2 Power Configurations

The DAC81408EVM provides electrical connections to the device supply pins. The connectors and optional configurations are shown in the [Table 4](#).

Table 4. Power Supply Inputs

Connector.Pin	Supply Name	Voltage Range
J7.3	GND	0 V
J7.4	VIO	1.7 V to 5.5 V
J7.5	VDD/VAA	4.5 V to 5.5 V
J7.6	VSS	-21.5 V to 0 V Note: $9\text{ V} < (VCC - VSS) < 43\text{ V}$
J7.7	VCC	9 V to 41.5 V
J8.5	VIO	1.7 V to 5.5 V Note: J10 selects between J7.4 and J8.5

2.1.3 Electrostatic Discharge Warning

Many of the components on the DAC81408EVM are susceptible to damage by electrostatic discharge (ESD). Observe proper ESD handling precautions when unpacking and handling the EVM, including the use of a grounded wrist strap at an approved ESD workstation.

2.2 Software Setup

This section provides the procedure for EVM software installation.

2.2.1 Operating Systems

The EVM software is compatible with the Windows™ 7, Windows 8, and Windows 10 operating systems.

2.2.2 Software Installation

The software is available through the EVM product folder on the TI website. After the software is downloaded to the PC, navigate to the *DAC81408EVM* folder, and run the *Setup_DAC81408_EVM.exe* file, as shown in [Figure 2](#). When the software is launched, an installation dialog window opens and prompts the user to select an installation directory. If left unchanged, the software location defaults to *C:\Program Files (x86)\Texas Instruments\DAC81408 EVM*, as shown in [Figure 2](#).

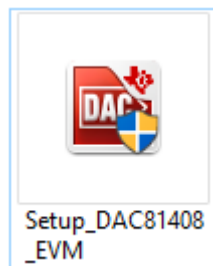

Figure 2. Launching Software Setup

The software installation automatically copies the required LabVIEW files and drivers to the local machine. Make sure to verify that the USB2ANY is not connected before the software installation, or the file and driver installation may be affected.

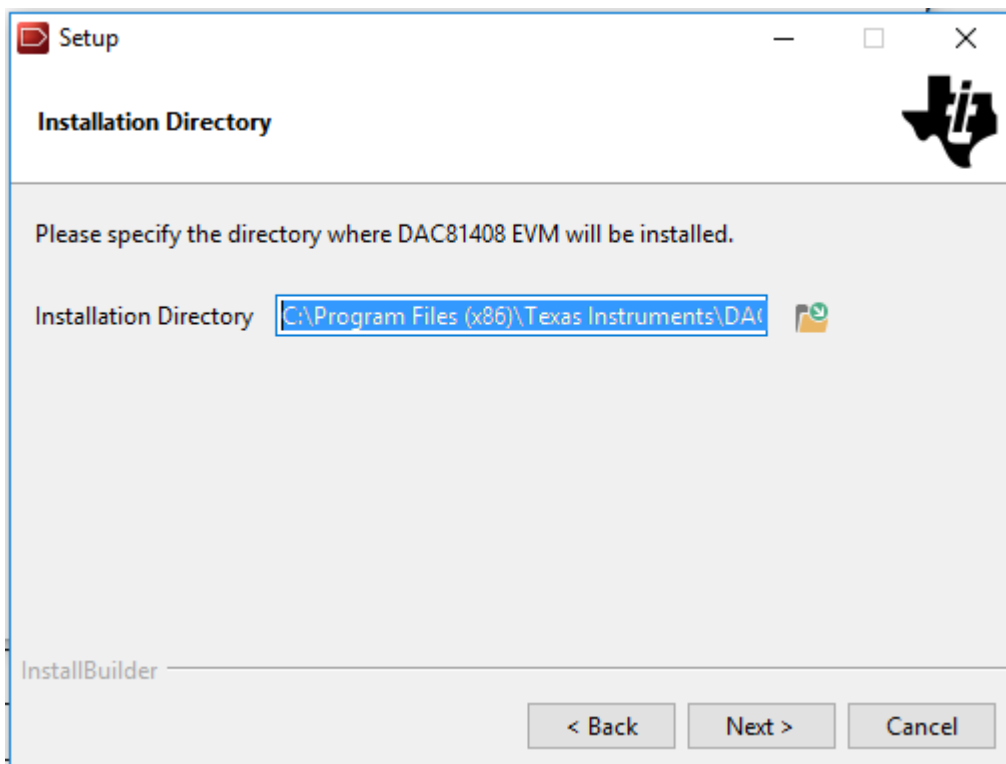

Figure 3. DAC81408EVM Installation Path

3 Detailed Description

3.1 Hardware Description

The following sections provide detailed information on the EVM hardware and jumper configuration settings. [Table 5](#) displays the default configurations of all jumper connections on the DAC81408EVM.

Table 5. Jumper Settings

Jumper	Default Position	Available Option	Description
J2	Open: RESET deactivated	Closed: RESET activated	RESET activation or deactivation
J3	Open: CLR deactivated	Closed: CLR activated	CLR activation or deactivation
J9	Closed: GND	Open: external REFGND	REFGND selection
J10	1-2: USB2ANY 3.3 V on J8.5	2-3: external VIO on J7.4	VIO selection
J11	1-2: VREF from REF5025	2-3: external VREF on J7.1	VREF selection note: deselect both before selecting internal reference
J12	2-3: VSS on J7.6	1-2: GND	VSS selection

3.1.1 Theory of Operation for DAC81408 Hardware

The block diagram of the DAC81408EVM board is displayed in [Figure 4](#). The EVM board connects to external power supplies VCC, VSS, VDD/VAA and VIO through an external 7-pin terminal block. This connector also provides an option for an external reference. The 32-pin header provides the eight DAC outputs and other signals, such as VREF, TEMPOUT and ALMOUT. The 10-pin wire-to-board connector provides an interface to the USB2ANY platform. The SPI signals are provided by using either the USB2ANY header or the test points. The USB2ANY also provides the optional 3.3-V VIO selectable by jumper settings. There is also an onboard 2.5-V reference source.

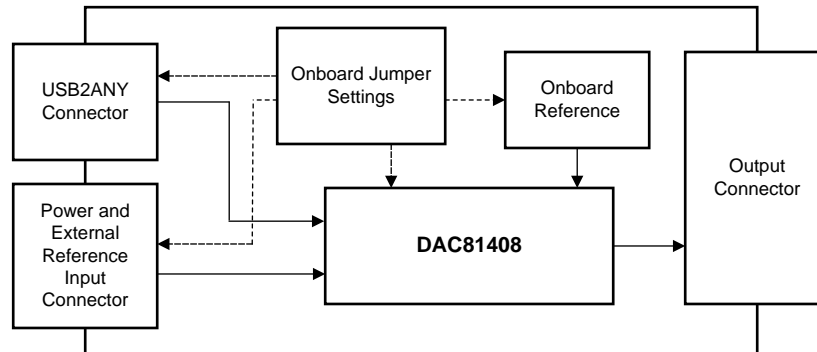

Figure 4. DAC81408EVM Hardware Block Diagram

3.1.2 Signal Definition of USB2ANY

The DAC81408EVM provides a hardware connector (J8) that connects to the USB2ANY interface board. The USBANY platform supplies VIO power and is responsible for providing the SPI commands sent from the PC GUI software. Optionally, the VIO supply can be provided through an external supply, and all digital communication lines can be accessed through their respective digital test points. [Table 6](#) provides the pin definitions for this connector. [Table 7](#) provides the corresponding test points for the SPI signals.

Table 6. J8 (USB2ANY) Pin Definitions

Pin#	Signal	Description
1	GPIO7	General purpose I/O
2	CS/GPIO6	\overline{CS} or general-purpose I/O
3	RXD/MISO	SPI MISO
4	TXD/MOSI	SPI MOSI
5	3.3V	3.3-V supply
6	GND	Ground
7	GPIO3	General-purpose I/O
8	SCLK/GPIO2	SPI SCLK or general-purpose I/O
9	GPIO1	General-purpose I/O
10	GPIO0	General-purpose I/O

Table 7. J8 SPI Signal Test Points

Test Points	SPI Signal
TP6	MISO, SDO
TP7	\overline{CS}
TP8	MOSI, SDI
TP9	\overline{LDAC}
TP10	SCLK

3.1.3 DAC Signal Pins

The DAC81408EVM provides access to all DAC outputs through connection J1, as shown in [Figure 5](#), and listed in [Table 8](#).

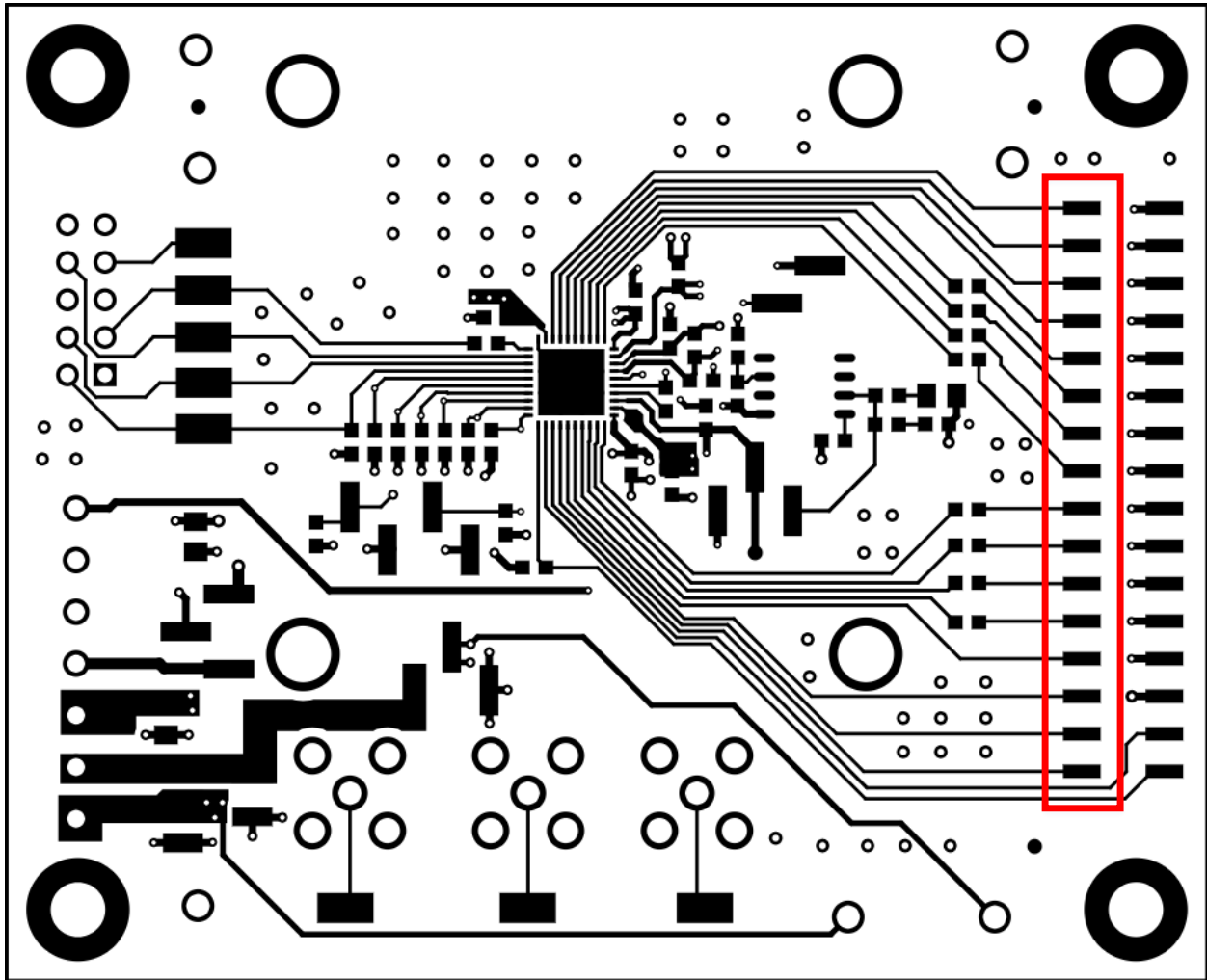
Figure 5. DAC Output Header
Table 8. J1 Pin Definitions

Name	Connector	Description
OUT0	J1.26	DAC output voltage
OUT1	J1.28	DAC output voltage
OUT2	J1.30	DAC output voltage
OUT3	J1.32	DAC output voltage
OUT4	J1.2	DAC output voltage
OUT5	J1.4	DAC output voltage
OUT6	J1.6	DAC output voltage
OUT7	J1.8	DAC output voltage
ALMOUT	J1.1	DAC alarm output
TEMPOUT	J1.3	DAC temperature output
REFGND	J1.5	DAC REFGND
VREF	J1.7	DAC reference
GND	J1.9, J1.11, J1.13, J1.15, J1.17, J1.19, J1.21, J1.23, J1.25, J1.27, J1.29, J1.31	DAC ground
NC	J1.10, J1.12, J1.14, J1.16, J1.18, J1.20, J1.22, J1.24	Not connected

3.2 Software Description

This section describes the features of the DAC81408 EVM software, and discusses how to use these features. The software provides basic control of all the registers and functions to the DAC81408 device.

3.2.1 Starting the Software

After the DAC81408 EVM software is installed, a restart may be required by Windows. To launch the software, locate the Texas Instruments folder in the *All Programs* menu, and select the *DAC81408 EVM* icon.

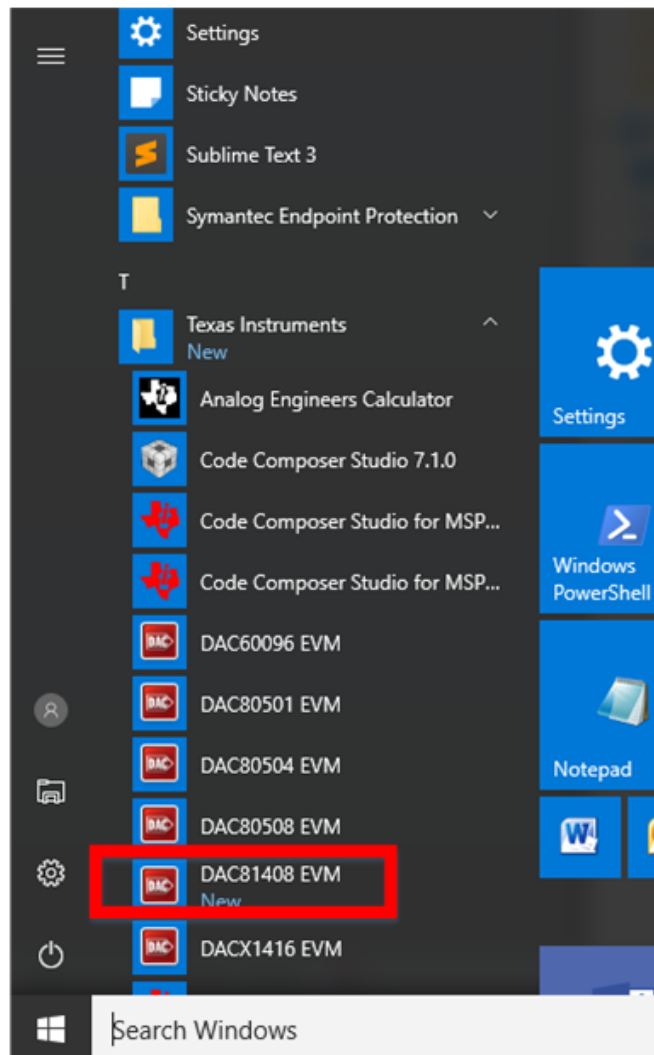

Figure 6. DAC81408EVM GUI Location

Figure 7 shows that the USB2ANY hardware is correctly connected because the status bar at the bottom of the screen displays *HARDWARE CONNECTED*. If the USB2ANY is not properly connected or not connected at all, the status bar displays *DEMO*. If the GUI is not displaying the *HARDWARE CONNECTED* status while the USB2ANY is connected, unplug and reconnect the USB2ANY, and relaunch the GUI software.



Figure 7. DAC81408EVM GUI Connection Detection

3.2.2 Software Features

The DAC81408 EVM incorporates interactive functions that help configure the DAC81408 device. These functions are built into several GUI pages, as shown in [Figure 8](#). Use the *Page Selection* menu to switch between the pages, with each page representing a feature of the software.

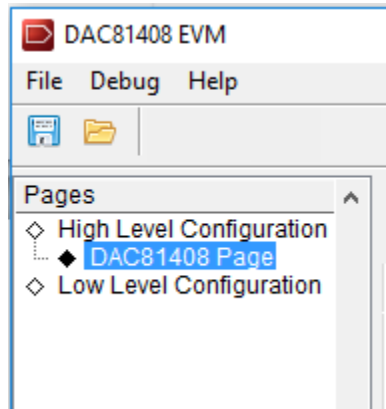

Figure 8. DAC81408EVM Software Page Selection

3.2.2.1 Low Level Configuration Page

The DAC81408 EVM *Register Map* page, shown in [Figure 9](#), provides access to low level communication directly with the DAC81408 registers. Selecting a register on the *Register Map* list shows a description of the values in that register, as well as information on the register address, default value, size, and current value. Values can be read and written to the registers by writing to the *Value* or bit field of the GUI.

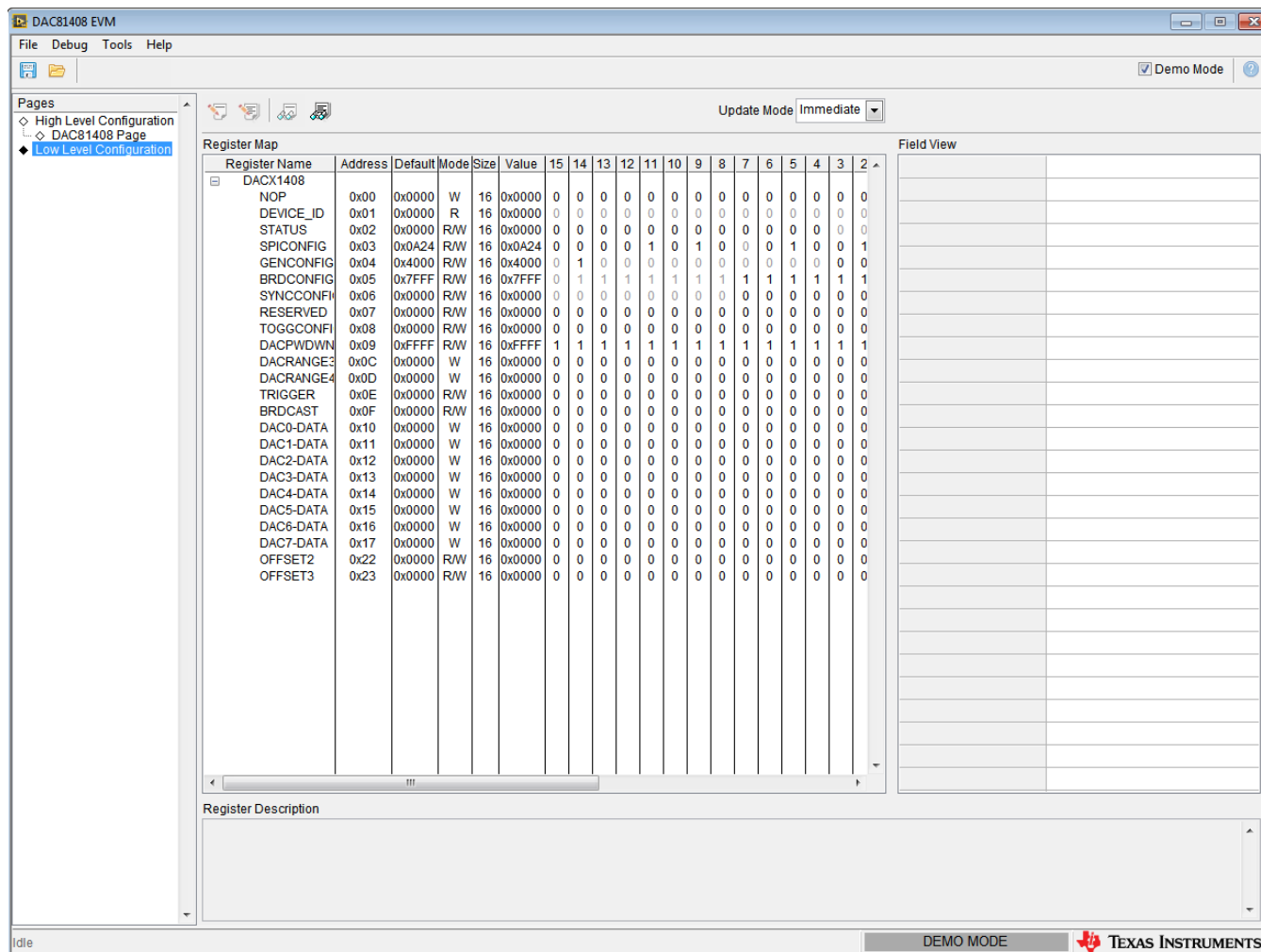

Figure 9. Low Level Configuration Page

The values of the register map can also be saved by pressing the *Save Configuration* button under the *File* menu option. Additionally, the configuration files can be accessed through the *Load Configuration* button. Other selectable options include the *Update Mode*, *Write Selected*, *Read Selected*, *Write Modified*, and *Read All* buttons. All buttons are displayed in Figure 10.

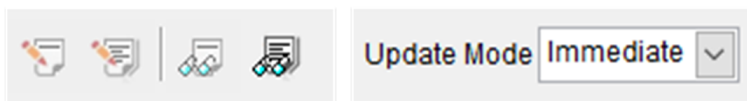

Figure 10. Low Level Configuration Page Options

If *Immediate* is selected under *Update Mode*, all changes to register values update immediately. Use the *Deferred* option to modify the value of a register without taking effect until the *Write Selected* or *Write Modified* button is pressed. The *Read Selected* button allows individual register reads, whereas the *Read All* button reads the status of all registers located in the register map.

3.2.2.2 High Level Configuration Page

The *High Level Configuration* page provides an interface to monitor and control the different data registers, modes, and configurations available for the DAC81408 device. This page is displayed in Figure 11.

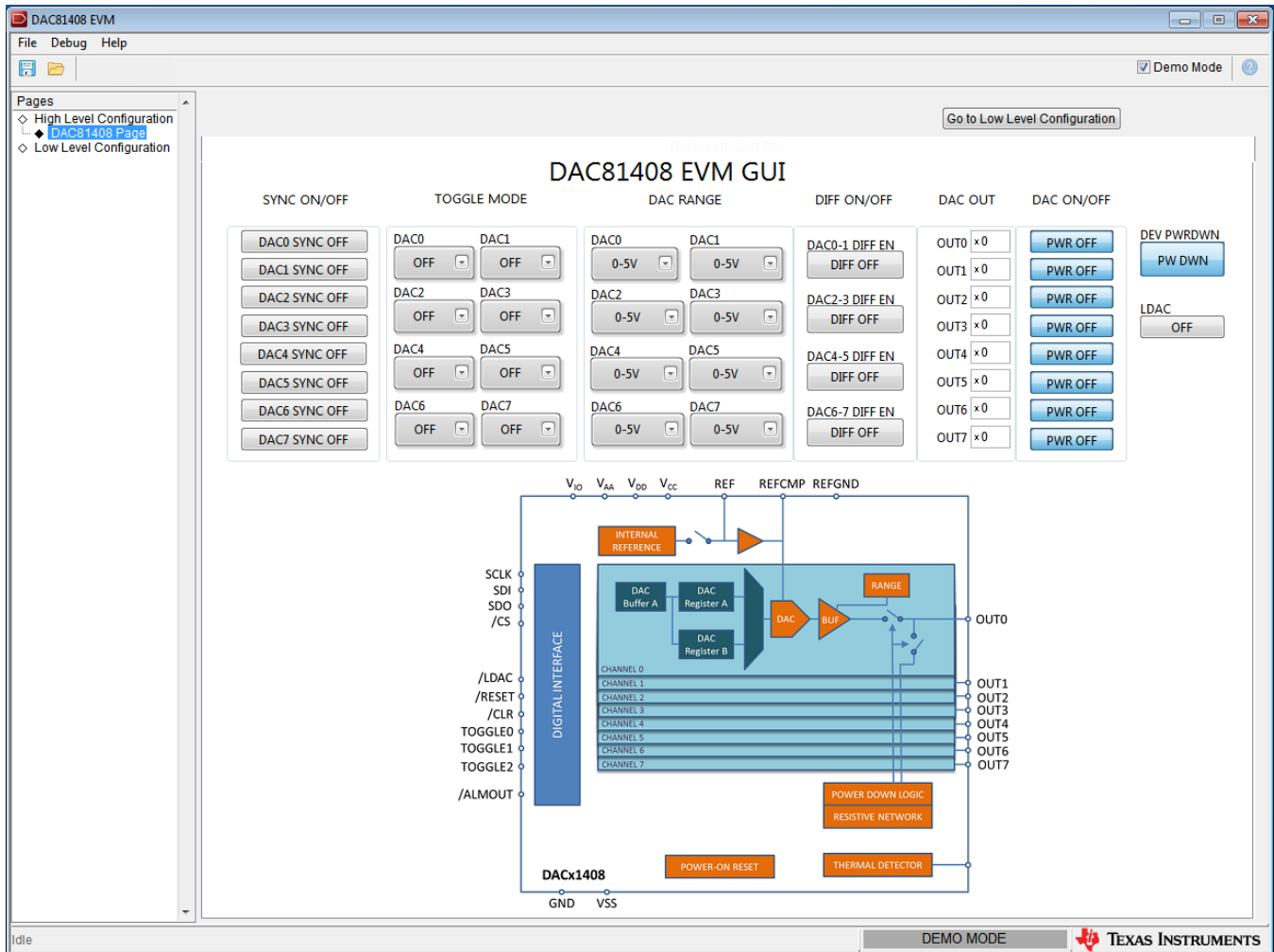

Figure 11. High Level Configuration Page

Power Down: The power-down bits of all eight DAC channels and the global power down bit are all enabled by default. Both the device and individual channels must be powered up in order to get output.

Reference: The internal voltage reference is by default OFF on DACx1408. The EVM selects the onboard reference by default.

Output Range: The DACx1408 provides various range options at individual channel level. This selection can be done on the GUI.

DAC Outputs: The DAC outputs can be operated either in single-ended or differential modes.

4 Schematic, PCB Layout, and Bill of Materials

This section contains the schematic diagram, printed circuit board layout, and a complete bill of materials for the DAC81408EVM.

4.1 Board Schematic

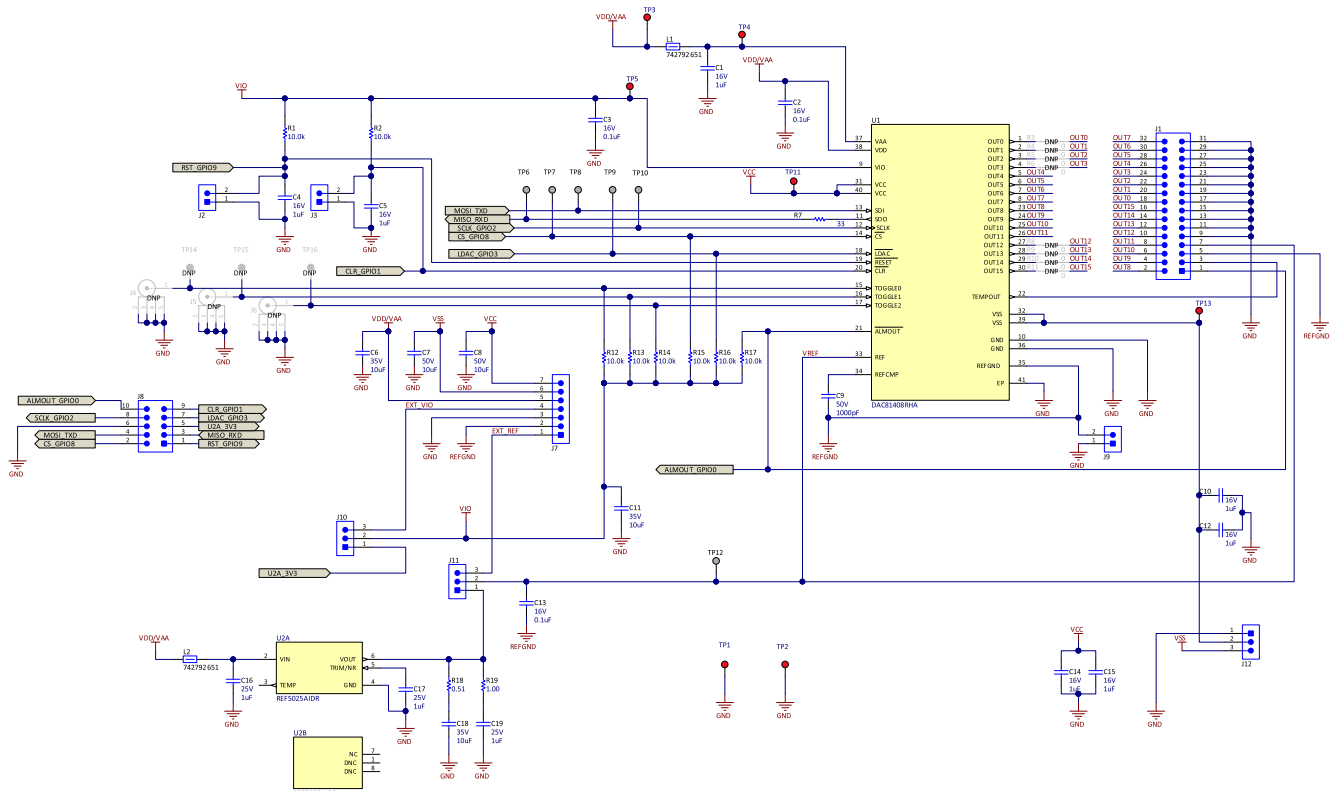

Figure 12. DAC81408EVM Board Schematic

4.2 PCB Components Layout

Figure 13 through Figure 17 show the layout of the components for the DAC81408EVM board.

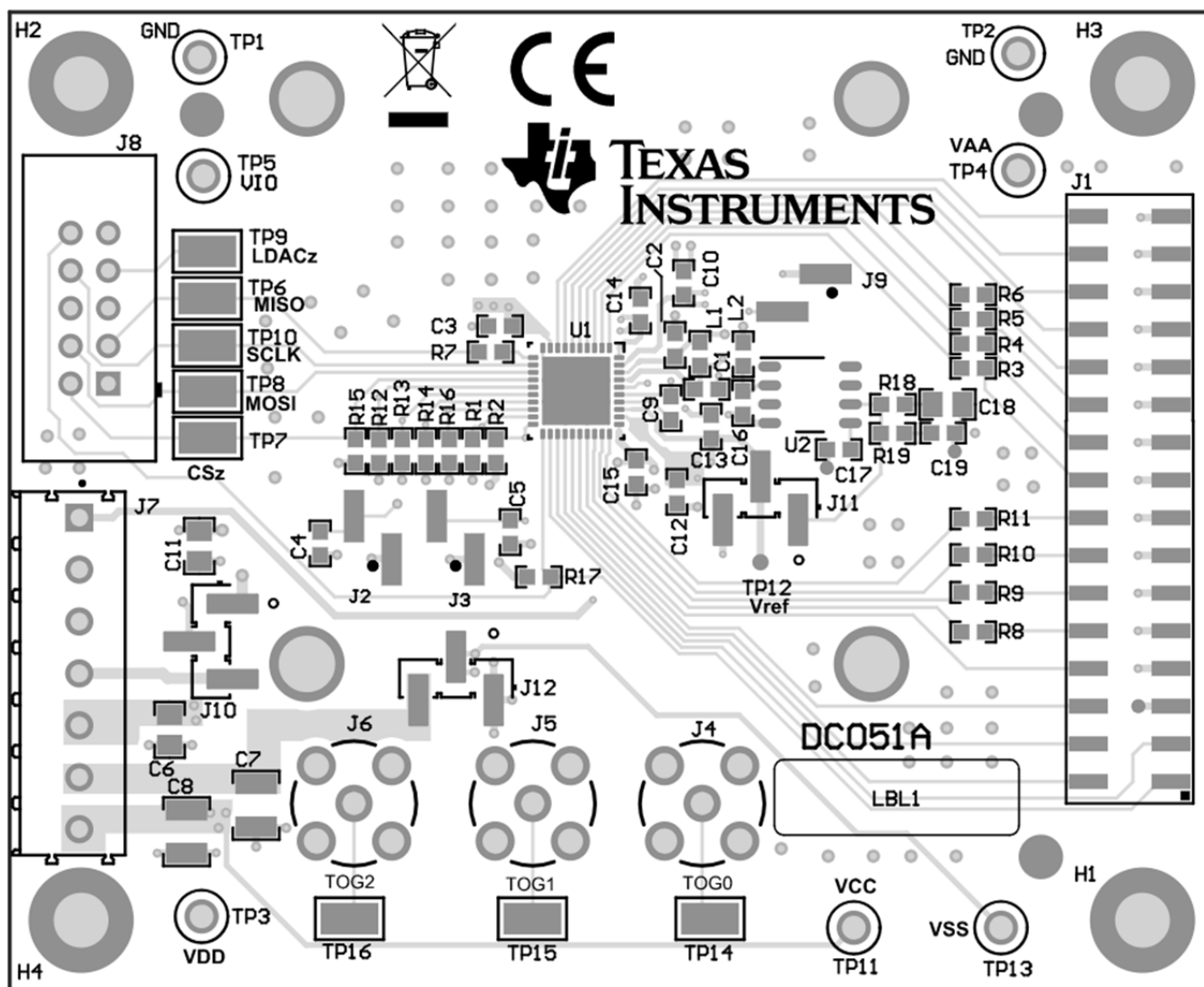
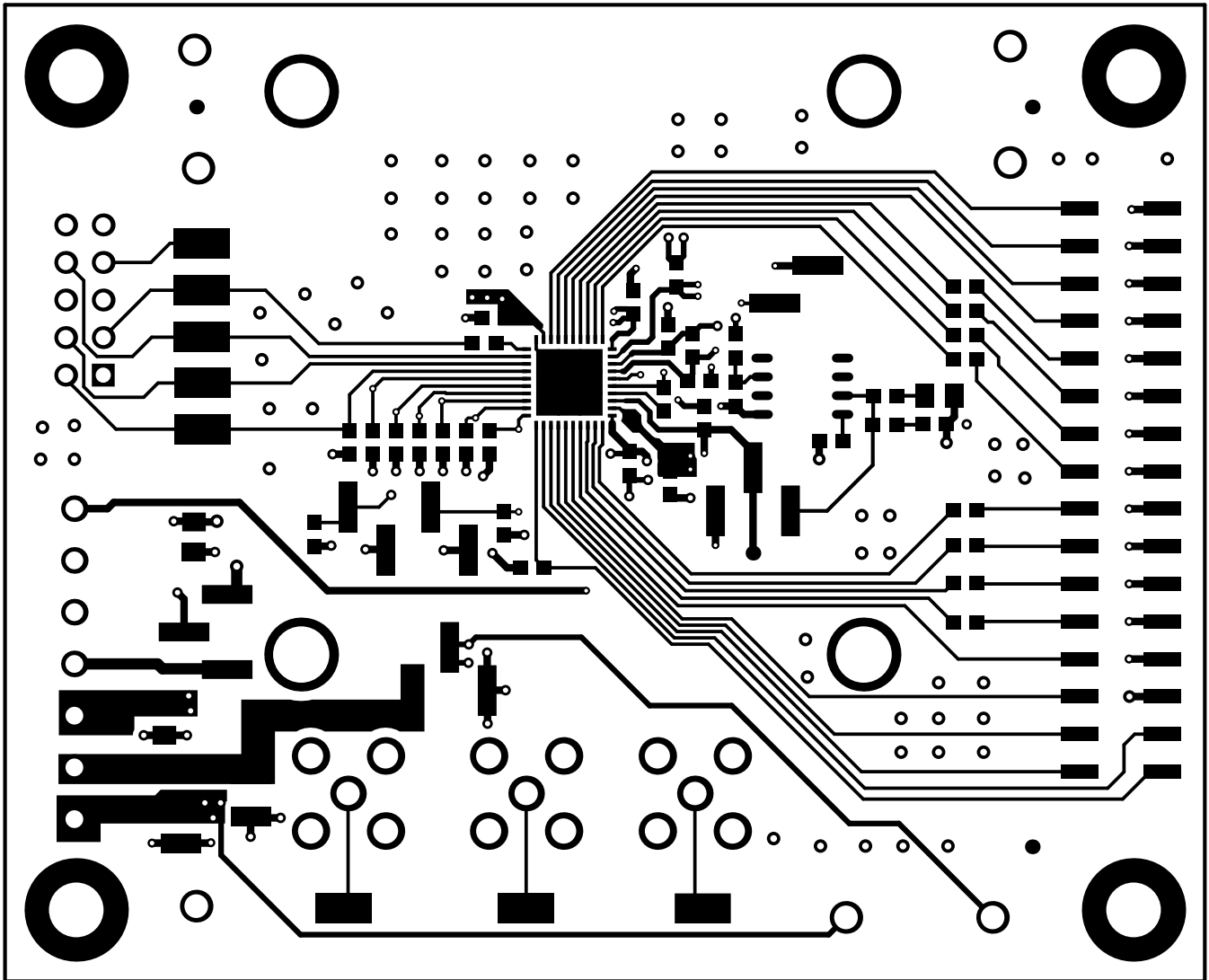
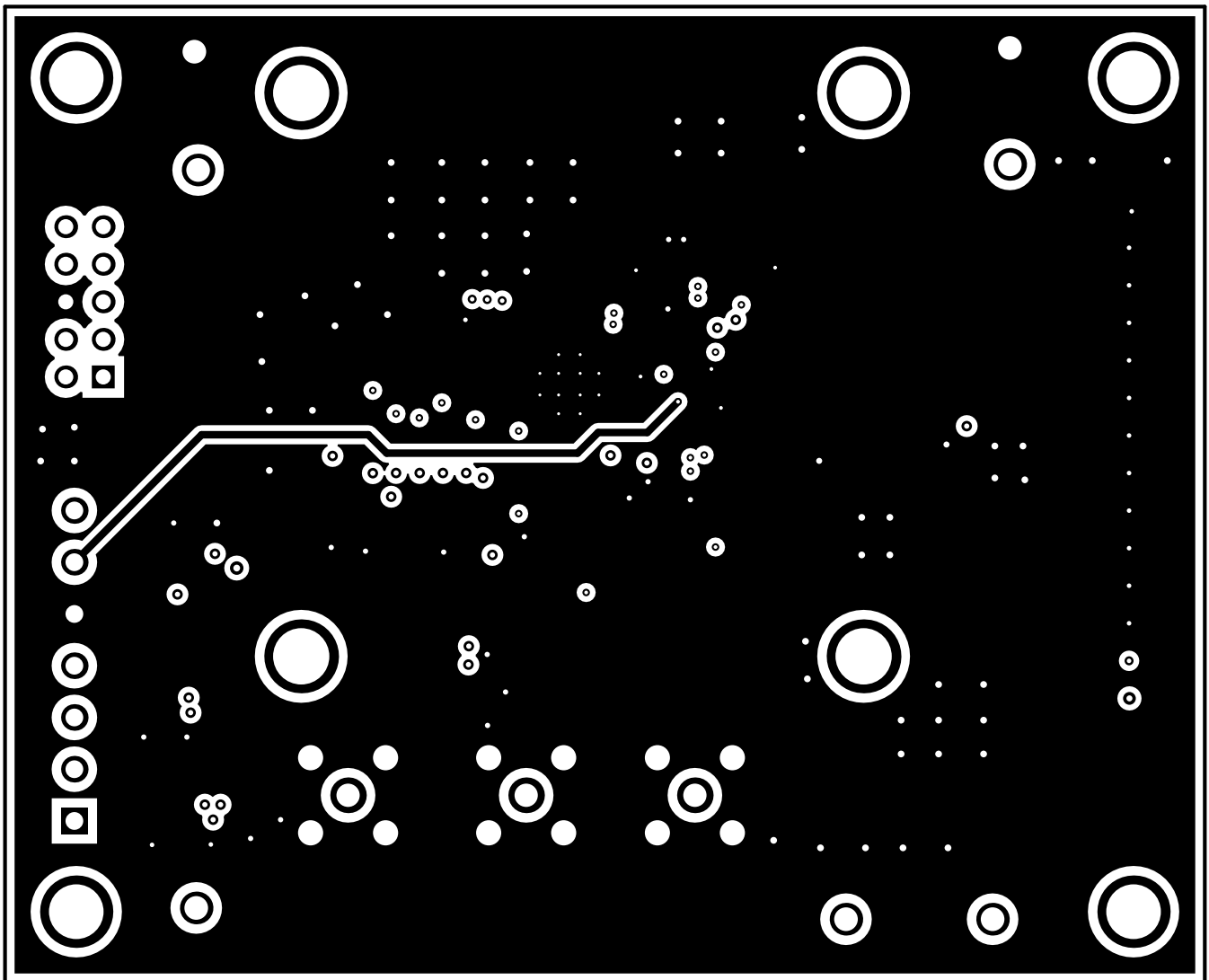

Figure 13. DAC81408EVM PCB Components Layout



L1-TOP

Figure 14. Top Layer



L2-GND

Figure 15. Layer 2 - Ground Plane

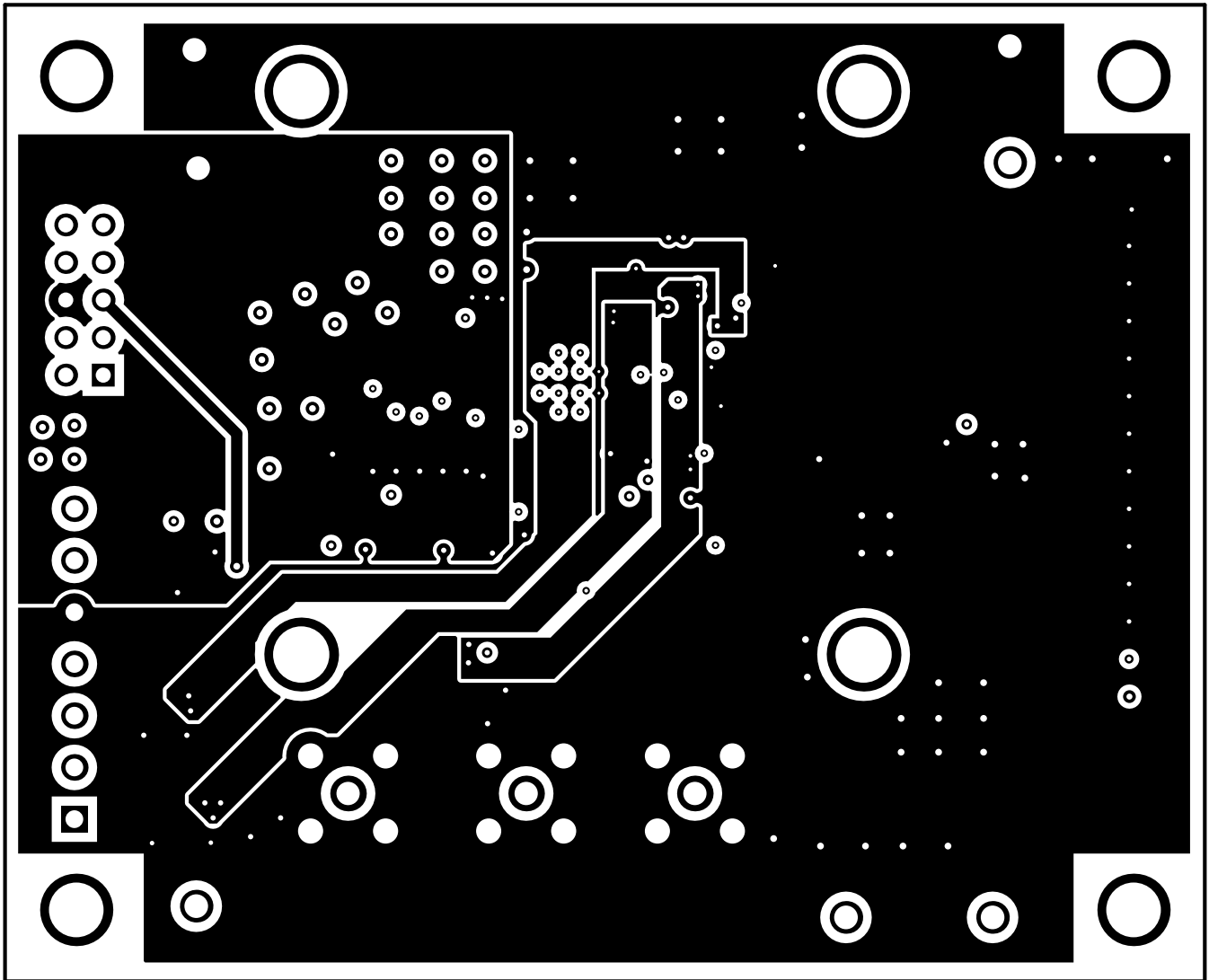

L3-POWER

Figure 16. Layer 3 - Power Plane

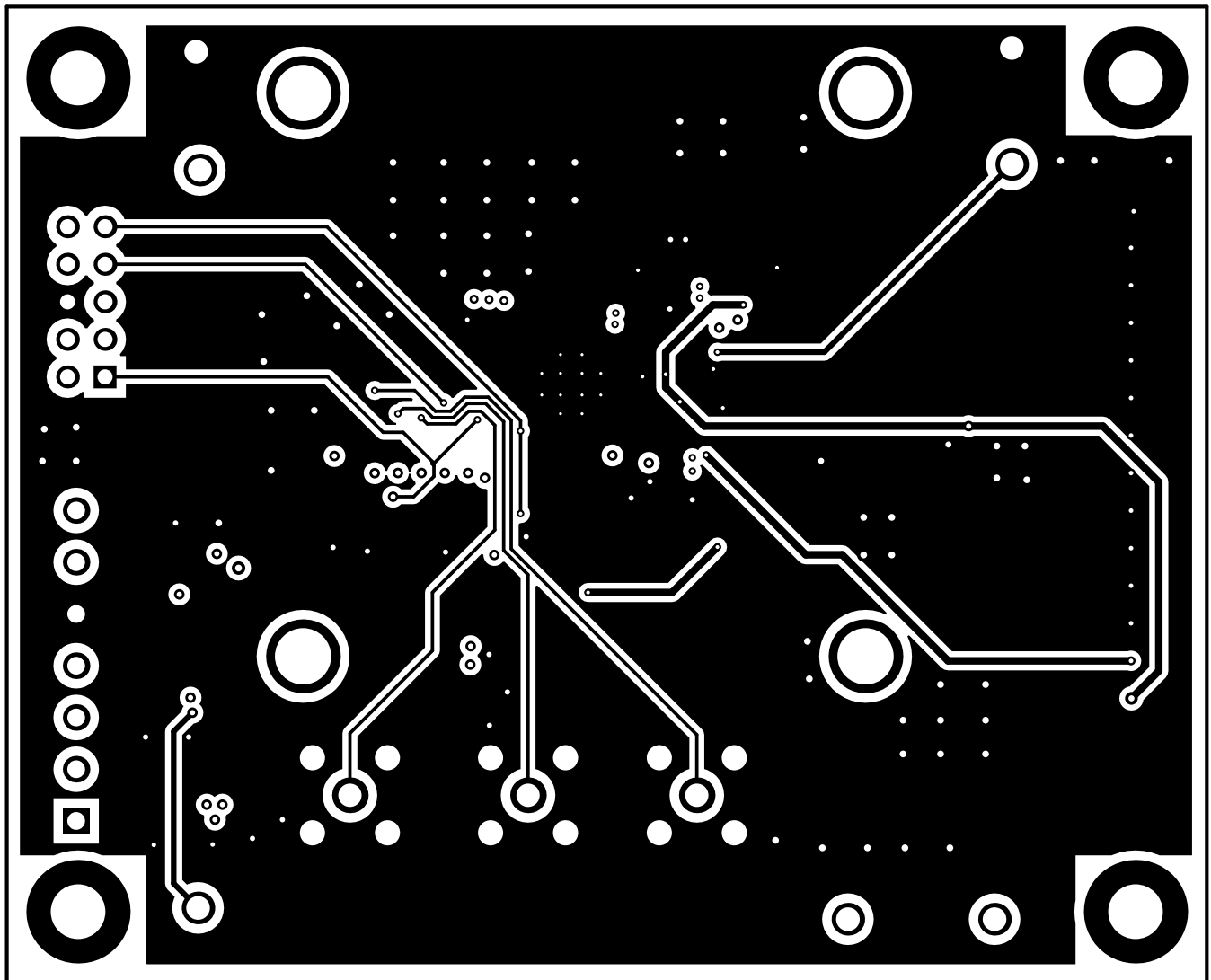

L4-BOTTOM

Figure 17. Bottom Layer

4.3 Bill of Materials

Table 9 lists the bill of materials (BOM).

Table 9. DAC81408 EVM Bill of Materials

Designator	Quantity	Value	Description	Package Reference	Part Number	Manufacturer
!PCB	1		Printed Circuit Board		DC051	Any
@H1, @H2, @H3, @H4	4		Hex Standoff, #4-40, Aluminum, 1/4"	1/4 inch Aluminum Hex Standoff	1891	Keystone
C1, C4, C5, C10, C12, C14, C15	7	1uF	CAP, CERM, 1 uF, 16 V, +/- 10%, X5R, 0603	0603	C0603C105K4PACTU	Kemet
C2, C3, C13	3	0.1uF	CAP, CERM, 0.1 uF, 16 V, +/- 5%, X7R, 0603	0603	C0603C104J4RACTU	Kemet
C6, C11, C18	3	10uF	CAP, CERM, 10 uF, 35 V, +/- 10%, X6S, 0805	0805	GRM21BC8YA106KE11L	MuRata
C7, C8	2	10uF	CAP, CERM, 10 uF, 50 V, +/- 10%, X7R, AEC-Q200 Grade 1, 1210	1210	UMJ325KB7106KMHT	Taiyo Yuden
C9	1	1000pF	CAP, CERM, 1000 pF, 50 V, +/- 10%, X7R, 0603	0603	C0603C102K5RACTU	Kemet
C16, C17, C19	3	1uF	CAP, CERM, 1 uF, 25 V, +/- 10%, X5R, 0603	0603	C1608X5R1E105K080A C	TDK
H1, H2, H3, H4	4		Screw Pan Head M3	Screw M3	29311	Keystone
J1	1		Header, 100mil, 16x2, Tin, SMT	16x2 Header	TSM-116-01-T-DV-P	Samtec
J2, J3, J9	3		Header, 100mil, 2x1, Gold with Tin Tail, SMT	2x1 Header	TSM-102-01-L-SV	Samtec
J7	1		TERM BLOCK, 7POS, 3.5MM, TH	24.5x9.2x7.6mm	1984662	Phoenix Contact
J8	1		Header(Shrouded), 2.54mm, 5x2, Gold, TH	Header, 2.54mm, 5x2, TH	AWHW-10G-0202-T	Assman WSW
J10, J11, J12	3		Header, 2.54mm, 3x1, Gold, SMT	Header, 2.54mm, 3x1, SMT	TSM-103-01-L-SV-P-TR	Samtec
L1, L2	2	600 ohm	Ferrite Bead, 600 ohm @ 100 MHz, 1 A, 0603	0603	742792651	Würth Elektronik
LBL1	1		Thermal Transfer Printable Labels, 0.650" W x 0.200" H - 10,000 per roll	PCB Label 0.650 x 0.200 inch	THT-14-423-10	Brady
R1, R2, R12, R13, R14, R15, R16, R17	8	10.0k	RES, 10.0 k, 1%, 0.1 W, 0603	0603	RC0603FR-0710KL	Yageo America

Table 9. DAC81408 EVM Bill of Materials (continued)

Designator	Quantity	Value	Description	Package Reference	Part Number	Manufacturer
R3, R4, R5, R6, R8, R9, R10, R11	8	0	RES, 0, 5%, 0.1 W, 0603	0603	RC0603JR-070RL	Yageo America
R7	1	33	RES, 33, 5%, 0.1 W, AEC-Q200 Grade 0, 0603	0603	CRCW060333R0JNEA	Vishay-Dale
R18	1	0.51	RES, 0.51, 1%, 0.1 W, AEC-Q200 Grade 1, 0603	0603	ERJ-3RQFR51V	Panasonic
R19	1	1.00	RES, 1.00, 1%, 0.1 W, 0603	0603	RC0603FR-071RL	Yageo America
SH-J1, SH-J2, SH-J3, SH-J4	4	1x2	Shunt, 100mil, Gold plated, Black	Shunt	SNT-100-BK-G	Samtec
TP1, TP2, TP3, TP4, TP5, TP11, TP13	7		Test Point, Compact, Red, TH	Red Compact Testpoint	5005	Keystone
TP6, TP7, TP8, TP9, TP10, TP14, TP15, TP16	8		Test Point, Miniature, SMT	Test Point, Miniature, SMT	5019	Keystone
U1	1		8-Channel, 16-Bit, High-Voltage Output DAC with Precision Internal Reference, RHA0040H (VQFN-40)	RHA0040H	DAC81408RHA	Texas Instruments
U2	1		Low Noise, Very Low Drift, Precision Voltage Reference, -40 to 125 degC, 8-pin SOIC (D), Green (RoHS & no Sb/Br)	D0008A	REF5025AIDR	Texas Instruments
H5	0		Square Basket Heatsink Featuring Slanted Fins	Heat Sink TO-3	500403B00000G	Aavid
J4, J5, J6	0		Connector, SMA, TH	SMA	142-0701-231	Cinch Connectivity

Revision History

Changes from Original (June 2018) to A Revision	Page
• Deleted USB2ANY adapter from Table 1	3
• Added new Table 2	3
• Changed contents of Table 4	4
• Changed connector.pin numbers in Table 5 to match the connector.pin numbers listed in Table 4.....	6
• Changed connector numbers in Table 8; updated for clarity	8

STANDARD TERMS FOR EVALUATION MODULES

1. *Delivery:* TI delivers TI evaluation boards, kits, or modules, including any accompanying demonstration software, components, and/or documentation which may be provided together or separately (collectively, an "EVM" or "EVMs") to the User ("User") in accordance with the terms set forth herein. User's acceptance of the EVM is expressly subject to the following terms.
 - 1.1 EVMs are intended solely for product or software developers for use in a research and development setting to facilitate feasibility evaluation, experimentation, or scientific analysis of TI semiconductor products. EVMs have no direct function and are not finished products. EVMs shall not be directly or indirectly assembled as a part or subassembly in any finished product. For clarification, any software or software tools provided with the EVM ("Software") shall not be subject to the terms and conditions set forth herein but rather shall be subject to the applicable terms that accompany such Software
 - 1.2 EVMs are not intended for consumer or household use. EVMs may not be sold, sublicensed, leased, rented, loaned, assigned, or otherwise distributed for commercial purposes by Users, in whole or in part, or used in any finished product or production system.
2. *Limited Warranty and Related Remedies/Disclaimers:*
 - 2.1 These terms do not apply to Software. The warranty, if any, for Software is covered in the applicable Software License Agreement.
 - 2.2 TI warrants that the TI EVM will conform to TI's published specifications for ninety (90) days after the date TI delivers such EVM to User. Notwithstanding the foregoing, TI shall not be liable for a nonconforming EVM if (a) the nonconformity was caused by neglect, misuse or mistreatment by an entity other than TI, including improper installation or testing, or for any EVMs that have been altered or modified in any way by an entity other than TI, (b) the nonconformity resulted from User's design, specifications or instructions for such EVMs or improper system design, or (c) User has not paid on time. Testing and other quality control techniques are used to the extent TI deems necessary. TI does not test all parameters of each EVM. User's claims against TI under this Section 2 are void if User fails to notify TI of any apparent defects in the EVMs within ten (10) business days after delivery, or of any hidden defects with ten (10) business days after the defect has been detected.
 - 2.3 TI's sole liability shall be at its option to repair or replace EVMs that fail to conform to the warranty set forth above, or credit User's account for such EVM. TI's liability under this warranty shall be limited to EVMs that are returned during the warranty period to the address designated by TI and that are determined by TI not to conform to such warranty. If TI elects to repair or replace such EVM, TI shall have a reasonable time to repair such EVM or provide replacements. Repaired EVMs shall be warranted for the remainder of the original warranty period. Replaced EVMs shall be warranted for a new full ninety (90) day warranty period.
3. *Regulatory Notices:*
 - 3.1 *United States*
 - 3.1.1 *Notice applicable to EVMs not FCC-Approved:*

FCC NOTICE: This kit is designed to allow product developers to evaluate electronic components, circuitry, or software associated with the kit to determine whether to incorporate such items in a finished product and software developers to write software applications for use with the end product. This kit is not a finished product and when assembled may not be resold or otherwise marketed unless all required FCC equipment authorizations are first obtained. Operation is subject to the condition that this product not cause harmful interference to licensed radio stations and that this product accept harmful interference. Unless the assembled kit is designed to operate under part 15, part 18 or part 95 of this chapter, the operator of the kit must operate under the authority of an FCC license holder or must secure an experimental authorization under part 5 of this chapter.
 - 3.1.2 *For EVMs annotated as FCC – FEDERAL COMMUNICATIONS COMMISSION Part 15 Compliant:*

CAUTION

This device complies with part 15 of the FCC Rules. Operation is subject to the following two conditions: (1) This device may not cause harmful interference, and (2) this device must accept any interference received, including interference that may cause undesired operation.

Changes or modifications not expressly approved by the party responsible for compliance could void the user's authority to operate the equipment.

FCC Interference Statement for Class A EVM devices

NOTE: This equipment has been tested and found to comply with the limits for a Class A digital device, pursuant to part 15 of the FCC Rules. These limits are designed to provide reasonable protection against harmful interference when the equipment is operated in a commercial environment. This equipment generates, uses, and can radiate radio frequency energy and, if not installed and used in accordance with the instruction manual, may cause harmful interference to radio communications. Operation of this equipment in a residential area is likely to cause harmful interference in which case the user will be required to correct the interference at his own expense.

FCC Interference Statement for Class B EVM devices

NOTE: This equipment has been tested and found to comply with the limits for a Class B digital device, pursuant to part 15 of the FCC Rules. These limits are designed to provide reasonable protection against harmful interference in a residential installation. This equipment generates, uses and can radiate radio frequency energy and, if not installed and used in accordance with the instructions, may cause harmful interference to radio communications. However, there is no guarantee that interference will not occur in a particular installation. If this equipment does cause harmful interference to radio or television reception, which can be determined by turning the equipment off and on, the user is encouraged to try to correct the interference by one or more of the following measures:

- Reorient or relocate the receiving antenna.
- Increase the separation between the equipment and receiver.
- Connect the equipment into an outlet on a circuit different from that to which the receiver is connected.
- Consult the dealer or an experienced radio/TV technician for help.

3.2 Canada

3.2.1 For EVMs issued with an Industry Canada Certificate of Conformance to RSS-210 or RSS-247

Concerning EVMs Including Radio Transmitters:

This device complies with Industry Canada license-exempt RSSs. Operation is subject to the following two conditions:

(1) this device may not cause interference, and (2) this device must accept any interference, including interference that may cause undesired operation of the device.

Concernant les EVMs avec appareils radio:

Le présent appareil est conforme aux CNR d'Industrie Canada applicables aux appareils radio exempts de licence. L'exploitation est autorisée aux deux conditions suivantes: (1) l'appareil ne doit pas produire de brouillage, et (2) l'utilisateur de l'appareil doit accepter tout brouillage radioélectrique subi, même si le brouillage est susceptible d'en compromettre le fonctionnement.

Concerning EVMs Including Detachable Antennas:

Under Industry Canada regulations, this radio transmitter may only operate using an antenna of a type and maximum (or lesser) gain approved for the transmitter by Industry Canada. To reduce potential radio interference to other users, the antenna type and its gain should be so chosen that the equivalent isotropically radiated power (e.i.r.p.) is not more than that necessary for successful communication. This radio transmitter has been approved by Industry Canada to operate with the antenna types listed in the user guide with the maximum permissible gain and required antenna impedance for each antenna type indicated. Antenna types not included in this list, having a gain greater than the maximum gain indicated for that type, are strictly prohibited for use with this device.

Concernant les EVMs avec antennes détachables

Conformément à la réglementation d'Industrie Canada, le présent émetteur radio peut fonctionner avec une antenne d'un type et d'un gain maximal (ou inférieur) approuvé pour l'émetteur par Industrie Canada. Dans le but de réduire les risques de brouillage radioélectrique à l'intention des autres utilisateurs, il faut choisir le type d'antenne et son gain de sorte que la puissance isotrope rayonnée équivalente (p.i.r.e.) ne dépasse pas l'intensité nécessaire à l'établissement d'une communication satisfaisante. Le présent émetteur radio a été approuvé par Industrie Canada pour fonctionner avec les types d'antenne énumérés dans le manuel d'usage et ayant un gain admissible maximal et l'impédance requise pour chaque type d'antenne. Les types d'antenne non inclus dans cette liste, ou dont le gain est supérieur au gain maximal indiqué, sont strictement interdits pour l'exploitation de l'émetteur.

3.3 Japan

3.3.1 *Notice for EVMs delivered in Japan:* Please see http://www.tij.co.jp/lstds/ti_ja/general/eStore/notice_01.page 日本国内に輸入される評価用キット、ボードについては、次のところをご覧ください。
http://www.tij.co.jp/lstds/ti_ja/general/eStore/notice_01.page

3.3.2 *Notice for Users of EVMs Considered "Radio Frequency Products" in Japan:* EVMs entering Japan may not be certified by TI as conforming to Technical Regulations of Radio Law of Japan.

If User uses EVMs in Japan, not certified to Technical Regulations of Radio Law of Japan, User is required to follow the instructions set forth by Radio Law of Japan, which includes, but is not limited to, the instructions below with respect to EVMs (which for the avoidance of doubt are stated strictly for convenience and should be verified by User):

1. Use EVMs in a shielded room or any other test facility as defined in the notification #173 issued by Ministry of Internal Affairs and Communications on March 28, 2006, based on Sub-section 1.1 of Article 6 of the Ministry's Rule for Enforcement of Radio Law of Japan,
2. Use EVMs only after User obtains the license of Test Radio Station as provided in Radio Law of Japan with respect to EVMs, or
3. Use of EVMs only after User obtains the Technical Regulations Conformity Certification as provided in Radio Law of Japan with respect to EVMs. Also, do not transfer EVMs, unless User gives the same notice above to the transferee. Please note that if User does not follow the instructions above, User will be subject to penalties of Radio Law of Japan.

【無線電波を送信する製品の開発キットをお使いになる際の注意事項】 開発キットの中には技術基準適合証明を受けていないものがあります。技術適合証明を受けていないものご使用に際しては、電波法遵守のため、以下のいずれかの措置を取っていただく必要がありますのでご注意ください。

1. 電波法施行規則第6条第1項第1号に基づく平成18年3月28日総務省告示第173号で定められた電波暗室等の試験設備でご使用いただく。
2. 実験局の免許を取得後ご使用いただく。
3. 技術基準適合証明を取得後ご使用いただく。

なお、本製品は、上記の「ご使用にあたっての注意」を譲渡先、移転先に通知しない限り、譲渡、移転できないものとします。

上記を遵守頂けない場合は、電波法の罰則が適用される可能性があることをご留意ください。日本テキサス・インスツルメンツ株式会社
東京都新宿区西新宿 6 丁目 2 4 番 1 号
西新宿三井ビル

3.3.3 *Notice for EVMs for Power Line Communication:* Please see http://www.tij.co.jp/lstds/ti_ja/general/eStore/notice_02.page
電力線搬送波通信についての開発キットをお使いになる際の注意事項については、次のところをご覧ください。 http://www.tij.co.jp/lstds/ti_ja/general/eStore/notice_02.page

3.4 *European Union*

3.4.1 *For EVMs subject to EU Directive 2014/30/EU (Electromagnetic Compatibility Directive):*

This is a class A product intended for use in environments other than domestic environments that are connected to a low-voltage power-supply network that supplies buildings used for domestic purposes. In a domestic environment this product may cause radio interference in which case the user may be required to take adequate measures.

4 *EVM Use Restrictions and Warnings:*

4.1 EVMS ARE NOT FOR USE IN FUNCTIONAL SAFETY AND/OR SAFETY CRITICAL EVALUATIONS, INCLUDING BUT NOT LIMITED TO EVALUATIONS OF LIFE SUPPORT APPLICATIONS.

4.2 User must read and apply the user guide and other available documentation provided by TI regarding the EVM prior to handling or using the EVM, including without limitation any warning or restriction notices. The notices contain important safety information related to, for example, temperatures and voltages.

4.3 *Safety-Related Warnings and Restrictions:*

4.3.1 User shall operate the EVM within TI's recommended specifications and environmental considerations stated in the user guide, other available documentation provided by TI, and any other applicable requirements and employ reasonable and customary safeguards. Exceeding the specified performance ratings and specifications (including but not limited to input and output voltage, current, power, and environmental ranges) for the EVM may cause personal injury or death, or property damage. If there are questions concerning performance ratings and specifications, User should contact a TI field representative prior to connecting interface electronics including input power and intended loads. Any loads applied outside of the specified output range may also result in unintended and/or inaccurate operation and/or possible permanent damage to the EVM and/or interface electronics. Please consult the EVM user guide prior to connecting any load to the EVM output. If there is uncertainty as to the load specification, please contact a TI field representative. During normal operation, even with the inputs and outputs kept within the specified allowable ranges, some circuit components may have elevated case temperatures. These components include but are not limited to linear regulators, switching transistors, pass transistors, current sense resistors, and heat sinks, which can be identified using the information in the associated documentation. When working with the EVM, please be aware that the EVM may become very warm.

4.3.2 EVMs are intended solely for use by technically qualified, professional electronics experts who are familiar with the dangers and application risks associated with handling electrical mechanical components, systems, and subsystems. User assumes all responsibility and liability for proper and safe handling and use of the EVM by User or its employees, affiliates, contractors or designees. User assumes all responsibility and liability to ensure that any interfaces (electronic and/or mechanical) between the EVM and any human body are designed with suitable isolation and means to safely limit accessible leakage currents to minimize the risk of electrical shock hazard. User assumes all responsibility and liability for any improper or unsafe handling or use of the EVM by User or its employees, affiliates, contractors or designees.

4.4 User assumes all responsibility and liability to determine whether the EVM is subject to any applicable international, federal, state, or local laws and regulations related to User's handling and use of the EVM and, if applicable, User assumes all responsibility and liability for compliance in all respects with such laws and regulations. User assumes all responsibility and liability for proper disposal and recycling of the EVM consistent with all applicable international, federal, state, and local requirements.

5. *Accuracy of Information:* To the extent TI provides information on the availability and function of EVMs, TI attempts to be as accurate as possible. However, TI does not warrant the accuracy of EVM descriptions, EVM availability or other information on its websites as accurate, complete, reliable, current, or error-free.

6. *Disclaimers:*
- 6.1 EXCEPT AS SET FORTH ABOVE, EVMS AND ANY MATERIALS PROVIDED WITH THE EVM (INCLUDING, BUT NOT LIMITED TO, REFERENCE DESIGNS AND THE DESIGN OF THE EVM ITSELF) ARE PROVIDED "AS IS" AND "WITH ALL FAULTS." TI DISCLAIMS ALL OTHER WARRANTIES, EXPRESS OR IMPLIED, REGARDING SUCH ITEMS, INCLUDING BUT NOT LIMITED TO ANY EPIDEMIC FAILURE WARRANTY OR IMPLIED WARRANTIES OF MERCHANTABILITY OR FITNESS FOR A PARTICULAR PURPOSE OR NON-INFRINGEMENT OF ANY THIRD PARTY PATENTS, COPYRIGHTS, TRADE SECRETS OR OTHER INTELLECTUAL PROPERTY RIGHTS.
- 6.2 EXCEPT FOR THE LIMITED RIGHT TO USE THE EVM SET FORTH HEREIN, NOTHING IN THESE TERMS SHALL BE CONSTRUED AS GRANTING OR CONFERRING ANY RIGHTS BY LICENSE, PATENT, OR ANY OTHER INDUSTRIAL OR INTELLECTUAL PROPERTY RIGHT OF TI, ITS SUPPLIERS/LICENSORS OR ANY OTHER THIRD PARTY, TO USE THE EVM IN ANY FINISHED END-USER OR READY-TO-USE FINAL PRODUCT, OR FOR ANY INVENTION, DISCOVERY OR IMPROVEMENT, REGARDLESS OF WHEN MADE, CONCEIVED OR ACQUIRED.
7. *USER'S INDEMNITY OBLIGATIONS AND REPRESENTATIONS.* USER WILL DEFEND, INDEMNIFY AND HOLD TI, ITS LICENSORS AND THEIR REPRESENTATIVES HARMLESS FROM AND AGAINST ANY AND ALL CLAIMS, DAMAGES, LOSSES, EXPENSES, COSTS AND LIABILITIES (COLLECTIVELY, "CLAIMS") ARISING OUT OF OR IN CONNECTION WITH ANY HANDLING OR USE OF THE EVM THAT IS NOT IN ACCORDANCE WITH THESE TERMS. THIS OBLIGATION SHALL APPLY WHETHER CLAIMS ARISE UNDER STATUTE, REGULATION, OR THE LAW OF TORT, CONTRACT OR ANY OTHER LEGAL THEORY, AND EVEN IF THE EVM FAILS TO PERFORM AS DESCRIBED OR EXPECTED.
8. *Limitations on Damages and Liability:*
- 8.1 *General Limitations.* IN NO EVENT SHALL TI BE LIABLE FOR ANY SPECIAL, COLLATERAL, INDIRECT, PUNITIVE, INCIDENTAL, CONSEQUENTIAL, OR EXEMPLARY DAMAGES IN CONNECTION WITH OR ARISING OUT OF THESE TERMS OR THE USE OF THE EVMS , REGARDLESS OF WHETHER TI HAS BEEN ADVISED OF THE POSSIBILITY OF SUCH DAMAGES. EXCLUDED DAMAGES INCLUDE, BUT ARE NOT LIMITED TO, COST OF REMOVAL OR REINSTALLATION, ANCILLARY COSTS TO THE PROCUREMENT OF SUBSTITUTE GOODS OR SERVICES, RETESTING, OUTSIDE COMPUTER TIME, LABOR COSTS, LOSS OF GOODWILL, LOSS OF PROFITS, LOSS OF SAVINGS, LOSS OF USE, LOSS OF DATA, OR BUSINESS INTERRUPTION. NO CLAIM, SUIT OR ACTION SHALL BE BROUGHT AGAINST TI MORE THAN TWELVE (12) MONTHS AFTER THE EVENT THAT GAVE RISE TO THE CAUSE OF ACTION HAS OCCURRED.
- 8.2 *Specific Limitations.* IN NO EVENT SHALL TI'S AGGREGATE LIABILITY FROM ANY USE OF AN EVM PROVIDED HEREUNDER, INCLUDING FROM ANY WARRANTY, INDEMNITY OR OTHER OBLIGATION ARISING OUT OF OR IN CONNECTION WITH THESE TERMS, , EXCEED THE TOTAL AMOUNT PAID TO TI BY USER FOR THE PARTICULAR EVM(S) AT ISSUE DURING THE PRIOR TWELVE (12) MONTHS WITH RESPECT TO WHICH LOSSES OR DAMAGES ARE CLAIMED. THE EXISTENCE OF MORE THAN ONE CLAIM SHALL NOT ENLARGE OR EXTEND THIS LIMIT.
9. *Return Policy.* Except as otherwise provided, TI does not offer any refunds, returns, or exchanges. Furthermore, no return of EVM(s) will be accepted if the package has been opened and no return of the EVM(s) will be accepted if they are damaged or otherwise not in a resalable condition. If User feels it has been incorrectly charged for the EVM(s) it ordered or that delivery violates the applicable order, User should contact TI. All refunds will be made in full within thirty (30) working days from the return of the components(s), excluding any postage or packaging costs.
10. *Governing Law:* These terms and conditions shall be governed by and interpreted in accordance with the laws of the State of Texas, without reference to conflict-of-laws principles. User agrees that non-exclusive jurisdiction for any dispute arising out of or relating to these terms and conditions lies within courts located in the State of Texas and consents to venue in Dallas County, Texas. Notwithstanding the foregoing, any judgment may be enforced in any United States or foreign court, and TI may seek injunctive relief in any United States or foreign court.

IMPORTANT NOTICE AND DISCLAIMER

TI PROVIDES TECHNICAL AND RELIABILITY DATA (INCLUDING DATASHEETS), DESIGN RESOURCES (INCLUDING REFERENCE DESIGNS), APPLICATION OR OTHER DESIGN ADVICE, WEB TOOLS, SAFETY INFORMATION, AND OTHER RESOURCES "AS IS" AND WITH ALL FAULTS, AND DISCLAIMS ALL WARRANTIES, EXPRESS AND IMPLIED, INCLUDING WITHOUT LIMITATION ANY IMPLIED WARRANTIES OF MERCHANTABILITY, FITNESS FOR A PARTICULAR PURPOSE OR NON-INFRINGEMENT OF THIRD PARTY INTELLECTUAL PROPERTY RIGHTS.

These resources are intended for skilled developers designing with TI products. You are solely responsible for (1) selecting the appropriate TI products for your application, (2) designing, validating and testing your application, and (3) ensuring your application meets applicable standards, and any other safety, security, or other requirements. These resources are subject to change without notice. TI grants you permission to use these resources only for development of an application that uses the TI products described in the resource. Other reproduction and display of these resources is prohibited. No license is granted to any other TI intellectual property right or to any third party intellectual property right. TI disclaims responsibility for, and you will fully indemnify TI and its representatives against, any claims, damages, costs, losses, and liabilities arising out of your use of these resources.

TI's products are provided subject to TI's Terms of Sale (www.ti.com/legal/termsofsale.html) or other applicable terms available either on ti.com or provided in conjunction with such TI products. TI's provision of these resources does not expand or otherwise alter TI's applicable warranties or warranty disclaimers for TI products.

Mailing Address: Texas Instruments, Post Office Box 655303, Dallas, Texas 75265
Copyright © 2018, Texas Instruments Incorporated